

Instructions for use



CE
0297

Surgical

Contra-angle handpieces with
mini LED+ and generator

WS-56 L G, WS-75 L G, WS-91 L G, WS-92 L G

Contra-angle handpieces without light

WS-56, WS-75, WS-91, WS-92

Symbols	4 – 5
in the Instructions for use [4], on the contra-angle handpiece / on the packaging [5]	
1. Introduction	6 – 8
2. Safety notes	9 – 14
General [9 – 11], Contra-angle handpiece with mini LED+ and generator [12 – 14]	
3. Product description	15 – 16
4. Operation	17 – 25
Assembly/Removal [17 – 19], To change rotary instrument [20 – 24], Test run [25]	

5. Hygiene and maintenance	26 – 46
General (26 – 27), Pre-disinfection (28), Disassemble (29), Manual cleaning (30 – 35), Manual disinfection (36), Mechanical cleaning/disinfection/lubrication (37 – 38), Reassemble (39), Oil service (40 – 43), Sterilization and storage (44 – 46)	
6. W&H Accessories and spare parts	47
7. Technical data	48 – 50
8. Recycling and disposal	51 – 52
Explanation of warranty terms	53
Authorized W&H service partners	55

stomdevice Symbols in the Instructions for use



WARNING!
(risk of injury)



ATTENTION!
(to prevent
damage occurring)



General explanations,
without risk to
persons or objects









Do not dispose of
with domestic waste

Caution!

Federal law restricts this device to sale by or on the order of a dentist, physician or any other practitioner licensed by the law of the State in which he or she practices to use or order the use of the device.

Symbols on the contra-angle handpiece / on the packaging

 CE 0297 from the manufacturer	REF Catalogue number		Data Matrix Code for product identification, e.g., in hygiene/maintenance process
 Thermo washer disinfectable	SN Serial number		
 Sterilizable up to the stated temperature	 Date of manufacture		UL Component Recognition Mark indicates compliance with Canadian and U.S. requirements

1. Introduction

Customer satisfaction has absolute priority in the W&H quality policy. This W&H product has been developed, manufactured and subjected to final inspection according to legal regulations, quality norms and industry standards.

For your safety and the safety of your patients

Prior to initial use please read the Instructions for use. These explain how to use your W&H product and guarantee a smooth and efficient operation.

Intended use

Surgical treatment of dental hard tissue.

Misuse may damage the contra-angle handpiece and hence cause risks and hazards for patient, user and third parties.

Qualifications of the user

The contra-angle handpiece is intended for use by suitably qualified, medical, technical and specialist staff only. We have based our development and design of the contra-angle handpiece on the physician target group.



Production according to EU Directive

The contra-angle handpiece is a medical product according to the EU Directive 93/42/EEC.



Responsibility of the manufacturer

The manufacturer can only accept responsibility for the safety, reliability and performance of the contra-angle handpiece when it is used in compliance with the following directions:

- > The contra-angle handpiece must be used in accordance with these Instructions for use.
- > The contra-angle handpiece has no components that can be repaired by the user. Modifications or repairs must only be undertaken by an authorized W&H service partner (see page 55).

Skilled application

The contra-angle handpiece is intended only for skilled application in surgery according to its purpose of use in compliance with the valid health and safety at work regulations, the valid accident prevention regulations as well as in compliance with these Instructions for use.

The contra-angle handpiece should be prepared for use and maintained by staff who have been trained in procedures for infection control, personal safety and patient safety.

Improper use, (e.g., through poor hygiene and maintenance), non-compliance with our instructions or the use of accessories and spare parts which are not approved by W&H, invalidates all claims under warranty and any other claims.

Service

In the event of operating malfunctions immediately contact an authorized W&H service partner (see page 55). Repairs and maintenance work must only be undertaken by an authorized W&H service partner.

2. Safety notes – General



- > The operation of the contra-angle handpiece is permitted only on dental units which correspond to the Medical Device Directive.
- > Always ensure the correct operating conditions and cooling function.
- > Always ensure that sufficient and adequate cooling is delivered and ensure adequate suction.
- > In case of coolant supply failure, the contra-angle handpiece must be stopped immediately.
- > Check the contra-angle handpiece for damage and loose parts each time before using (e.g., push-button).
- > Do not operate the contra-angle handpiece if it is damaged.
- > Only attach the contra-angle handpiece onto the motor, when the motor is at a complete standstill.
- > Never touch the push-button of the contra-angle handpiece during operation or while it is still running down.
- > Never touch the rotary instrument which is still rotating.
- > Perform a test run each time before using.
- > Avoid overheating at the treatment site.
- > Do not touch the soft tissue with the contra-angle head (risk of burning due to the push-button heating up)!



The WS-75 L G / WS-75 contra-angle handpiece has a considerably higher level of efficiency than normal contra-angle handpieces and has been designed to fit the W&H drive units Implantmed SI-95, Implantmed SI-923 / SI-915, Elcomed SA-200 / SA-200 C and Elcomed SA-310.

If using a drive unit other than one for which the WS-75 L G / WS-75 has been designed, the setting for the required torque must be reduced by roughly one half. E.g., to achieve 50 Ncm on the rotating instrument with an W&H Elcomed 100/200, the torque must be set to 30 Ncm.

The use of the contra-angle handpiece WS-75 L G / WS-75 on surgical units other than the Implantmed SI-95, Implantmed SI-923 / SI-915, Elcomed SA-200 / SA-200 C and Elcomed SA-310, in particular those without a calibration function, represents a risk which must be considered by the user (risk of injury). W&H explicitly advises against doing this. The user is solely responsible. No liability is accepted by W&H.

Hygiene and maintenance prior to initial use



The contra-angle handpiece is in a clean condition and sealed in PE-film when delivered.

- > Lubricate the contra-angle handpiece.
- > Sterilize the contra-angle handpiece, the nozzle cleaner, the Y-manifold, the spray clips and the coolant tube for internal bur cooling.

- > Oil service page 40
- > Sterilization page 44

2. Safety notes – Contra-angle handpiece with mini LED+ and generator



- > Avoid contact between LED and soft tissue (risk of burning due to the LED heating up).
- > Do not use the contra-angle handpiece as light sensor.
- > Do not look directly into the LED.



Danger zones M and G

In accordance with IEC 60601-1 / ANSI/AAMI ES 60601-1, the contra-angle handpiece is not suitable for use in potentially explosive atmospheres or with potentially explosive mixtures of anaesthetic substances containing oxygen or nitrous oxide.



The contra-angle handpiece is not suitable for use in oxygen enriched atmospheres.



Zone M is defined as a »medical environment« and constitutes the part of a room in which potentially explosive atmospheres may form due to the use of anaesthetics or medical antiseptics and antibacterial soaps; such atmospheres are typically localized and temporary.

Zone M comprises a truncated pyramid below the operating table which is tilted outwards at a 30° angle.



Zone G, also known as an »enclosed medical gas system«, does not necessarily include areas enclosed around all sides, in which explosive mixtures are continuously or temporarily generated, directed or used in small quantities.



Risks due to electromagnetic fields

The functionality of implantable systems, such as cardiac pacemakers and implantable cardioverter defibrillator (ICD) can be affected by electric, magnetic and electromagnetic fields.

- > Find out if patient and user have implanted systems before using the product and consider the application.
- > Weigh the risks and benefits.
- > Keep the product away from implanted systems.
- > Make appropriate emergency provisions and take immediate action on any signs of ill-health.
- > Symptoms such as raised heartbeat, irregular pulse and dizziness can be signs of a problem with a cardiac pacemaker or ICD.

3. Product description

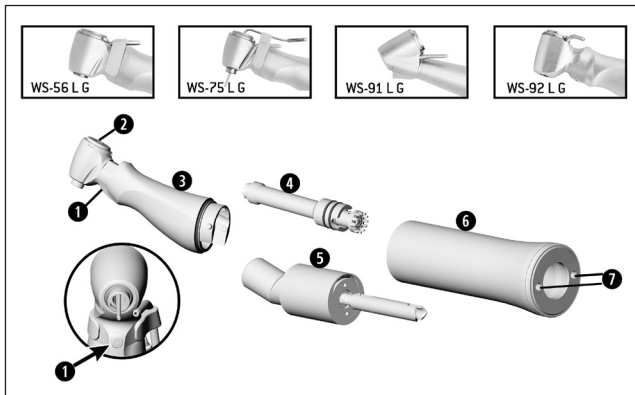

WS-56 L G, WS-75 L G, WS-91 L G, WS-92 L G

- ① LED
- ② Push-button
- ③ Contra-angle head*
- ④ Middle gear
- ⑤ Knee (with generator)
- ⑥ Sheath*
- ⑦ Hole for locking pin

* Symbols on the parts ③ and ⑥

- = Sheath open
- ▲ = Sheath locked
- ↔ = Direction of rotation

3. Product description – Continuation

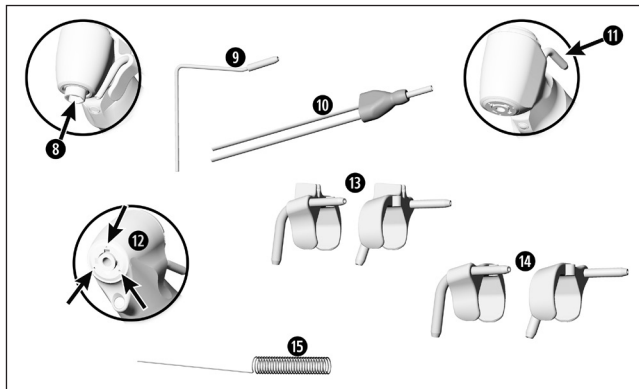

WS-75 L G, WS-75

- 8 Hexagon chucking system
- 9 Coolant tube for internal bur cooling
- 10 Y-manifold

WS-91 L G, WS-91, WS-92 L G, WS-92

- 11 External coolant tube
- 12 Spray nozzles
- 13 Spray clip for the left and right for Kirschner/Meyer internal bur cooling system
- 14 Spray clip for the left and right without internal bur cooling system
- 15 Nozzle cleaner

4. Operation – Assembly/Removal

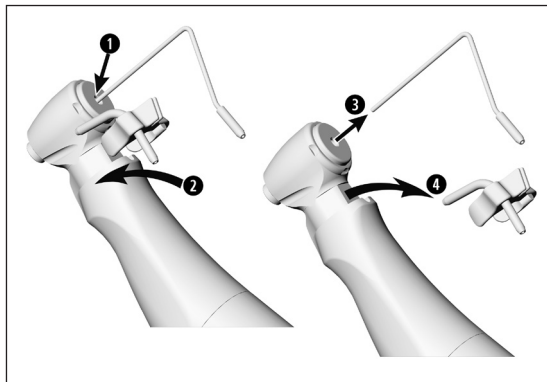

WS-75 L G, WS-75

Spray clip

Coolant tube for internal bur cooling

- 1 Attach the spray clip.
 - 2 Insert the coolant tube for internal bur cooling.
- or
- 3 Remove the coolant tube for internal bur cooling.
 - 4 Remove the spray clip.

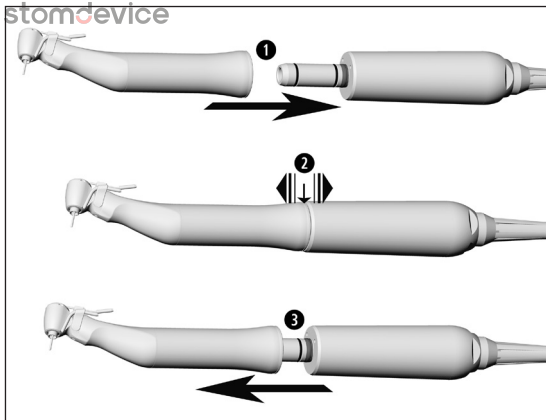

Contra-angle handpiece



Do not assemble or remove the contra-angle handpiece during the operation!

- 1** Push the contra-angle handpiece onto the motor.



When using a locking pin between motor and contra-angle handpiece:
See Instructions for use of the unit.

- 2** Check the secure hold on the motor.
or
- 3** Remove the contra-angle handpiece from the motor by pulling in an axial direction or by pressing the release button.

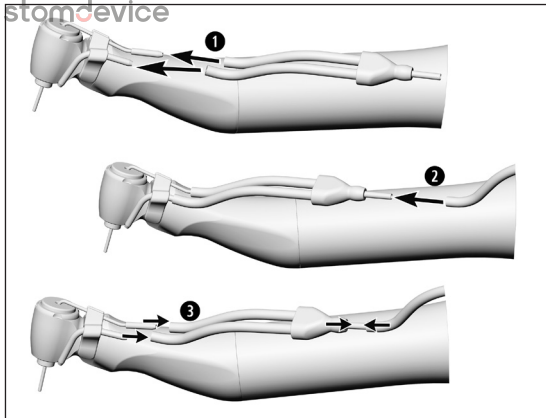
**WS-75 L G, WS-75****Y-manifold**

Only when using the coolant tube for internal bur cooling.

- 1 Insert the coolant hose of the Y-manifold onto the coolant tube of the spray clip and onto the coolant tube for internal bur cooling.
- 2 Insert the Y-manifold into the irrigation tubing.
or
- 3 Remove the Y-manifold.

Rotary instruments



- > Use only rotary instruments which are in perfect condition and pay attention to the direction of rotation of the rotary instrument. Follow the operating instructions of the manufacturer.
- > Insert the rotary instrument only when the contra-angle is stationary.
- > Never touch the rotary instrument which is still rotating.
- > Do not activate the push-button of the contra-angle handpiece during operation. This leads to detachment of the rotary instrument and/or makes the contra-angle hot.

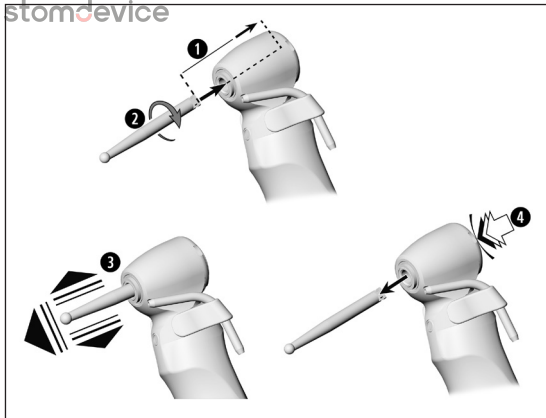

To change rotary instrument

WS-56 L G, WS-56

> Instrument shaft diameter 2.35 mm

- 1 Insert the rotary instrument until back stop.
 - 2 Turn the rotary instrument until it engages.
 - 3 Check secure location by applying slight axial tension.
- or
- 4 Activate the push-button and remove the rotary instrument.

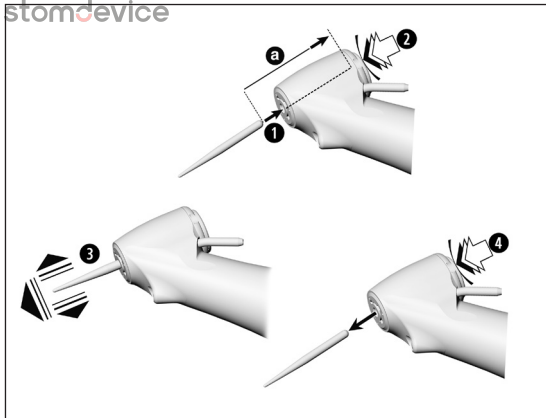
**WS-91 L G, WS-91, WS-92 L G, WS-92**

> Instrument shaft diameter 1.6 mm

- 1** Insert the rotary instrument.
- 2** Activate the push-button, at the same time insert the rotary instrument until back stop (a).
- 3** Check secure location by applying slight axial tension.

or

- 4** Activate the push-button and remove the rotary instrument.

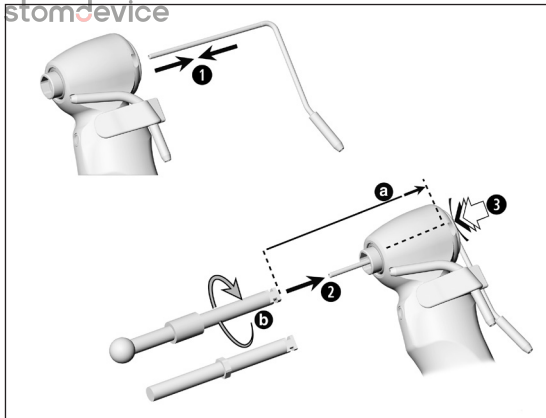

WS-75 L G, WS-75

- > *Using internal bur cooling*
- > *Without using internal bur cooling*
- > *With hexagon*
- > *Instrument shaft diameter 2.35 mm*

1 *Insert the coolant tube for internal bur cooling.*

or

- 1** *Remove the coolant tube for internal bur cooling.*
- 2** *Insert the rotary instrument **over the coolant tube** until back stop [a].*
- 3** *Activate the push-button and turn the rotary instrument until it engages [b].*

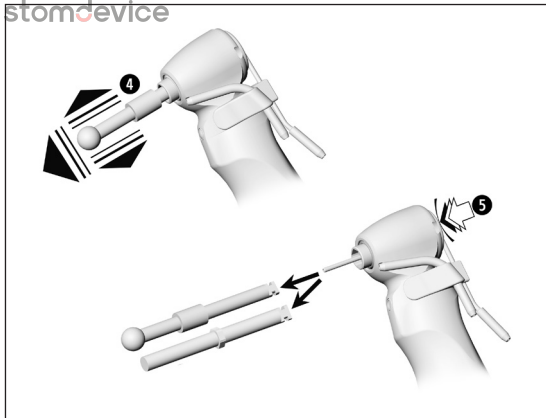

④ Check secure location by applying slight axial tension.

or

⑤ Activate the push-button and remove the rotary instrument.



Ask your implant supplier for an applicable rotary instrument with hexagon.



Do not hold the contra-angle handpiece at eye level.

- > Insert the rotary instrument.
- > Start the contra-angle handpiece.



In the event of operating malfunctions (e.g., vibrations, unusual noise, overheating, coolant failure or leakage) or discoloration of the LED, **stop the contra-angle handpiece immediately** and contact an authorized W&H service partner (see page <ÜS>).

5. Hygiene and maintenance



- > Follow your country-specific directives, standards and guidelines for cleaning, disinfection and sterilization.
- > You can process the contra-angle handpiece manually or mechanically.



- > Wear protective clothing.
- > Remove the contra-angle handpiece from the motor.
- > Remove the rotary instrument.



- > Clean and disinfect the contra-angle handpiece **immediately after every treatment**, to flush out any liquid (such as blood, saliva etc.) and to prevent settling on the internal parts.



After manual cleaning, disinfection and lubrication you must carry out a final sterilization (wrapped) in the class B or S steam sterilizer according to EN 13060.

For USA and Canada: Hospital grade sterilization with pre and post vacuum cycle.



Reassemble the contra-angle handpiece following manual cleaning and disinfection.

- > Without spray clip
- > Types and serial numbers must be identical



> Sterilize the reassembled contra-angle handpiece following manual or mechanical cleaning, disinfection and lubrication.

- > Sterilize the spray clip.

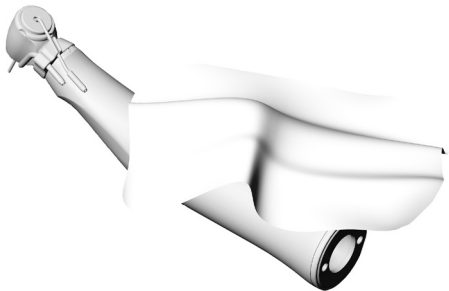

Pre-disinfection

- > If heavily soiled: Clean first with disinfectant cloths.



Only use disinfectants that have no protein-fixing effects.

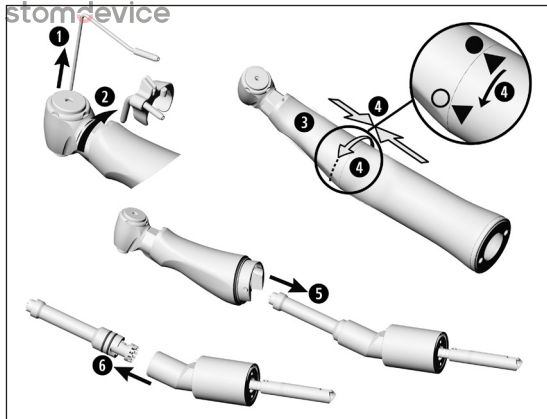

Disassemble contra-angle handpiece

- 1 Remove the coolant tube for internal bur cooling.
- 2 Remove the spray clip.
- 3 Hold the contra-angle head firmly with one hand.
- 4 Press sheath gently against knee. At the same time turn off the sheath from the knee.
- 5 Remove the knee from the contra-angle head.
- 6 Remove the middle gear from the knee.

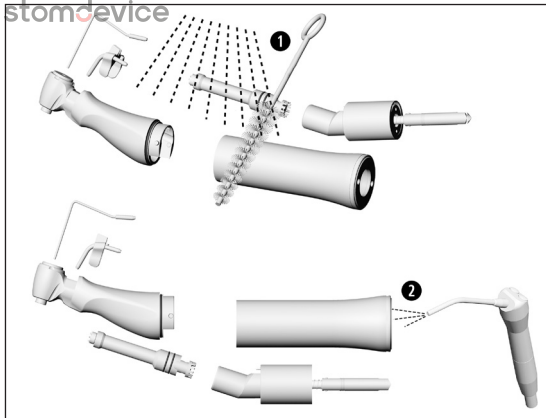

Manual cleaning internal and external

- 1 Rinse and brush off under demineralized water (< 38 °C / < 100 °F).
- 2 Remove any liquid residues (absorbent cloth, blow dry with compressed air).



Do not place the contra-angle handpiece in liquid disinfectant or in an ultrasonic bath.

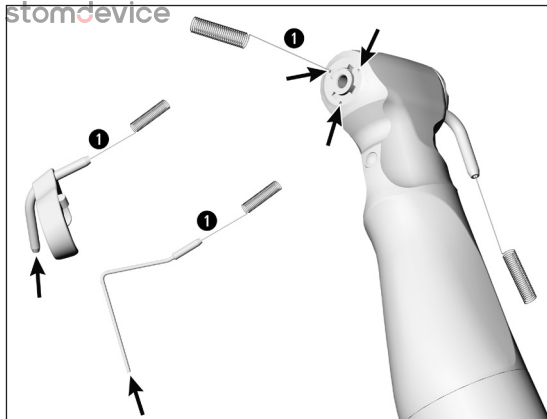

**Cleaning of the external coolant tubes
Cleaning of the spray nozzles with WS-91 L G,
WS-91, WS-92 L G, WS-92**



The coolant tube for internal bur cooling, the spray clips and the nozzle cleaner can be cleaned in an ultrasonic bath.

- 1** Clean coolant outlets carefully with the nozzle cleaner to remove dirt and deposits.

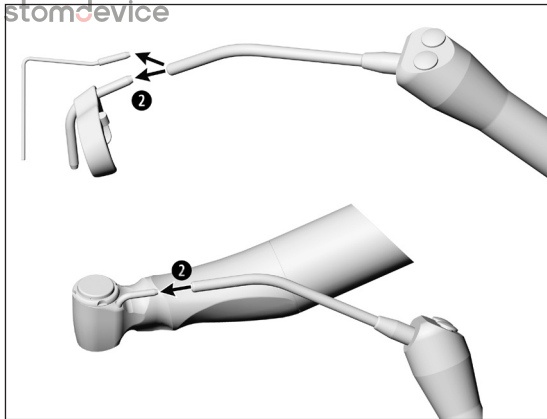

- 2 Blow through the coolant tube and coolant outlets with the air syringe.



In case of blocked coolant outlets or coolant tubes contact an authorized W&H service partner (see page 55).

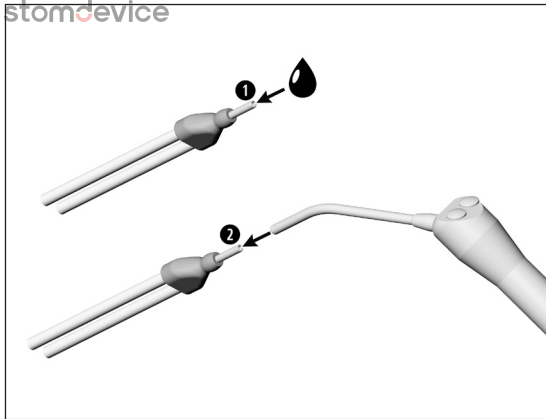

WS-75 L G, WS-75

Cleaning of the Y-manifold



The Y-manifold can be cleaned in an ultrasonic bath and/or in a thermo washer disinfectant.

- 1** Rinse with demineralized water (< 38 °C / < 100 °F).
- 2** Remove any liquid residues using compressed air.

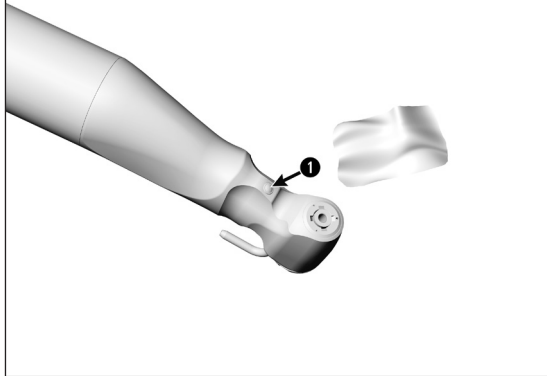

WS-56 L G, WS-75 L G, WS-91 L G, WS-92 L G

Cleaning of the LED



Avoid scratching of the LED!

- 1 Wash the LED with cleaning fluid and a soft cloth.

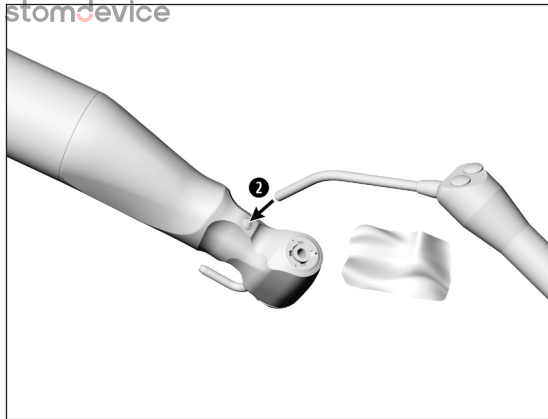

- 2 Blow the LED dry with air syringe or dry it carefully with a soft cloth.



Carry out a visual inspection after each cleaning process.
Do not use the contra-angle handpiece if the LED is damaged and contact an authorized W&H service partner (see page 55).

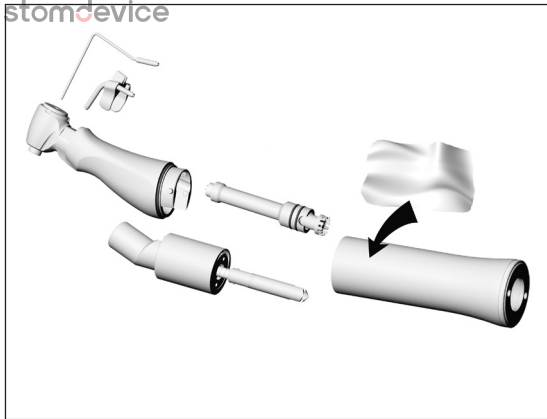

Manual disinfection



W&H recommends wiping down with disinfectant.

- > Use only disinfectants which do not contain chlorine and which are certified by officially recognized institutes.

For USA and Canada: Use EPA registered surface disinfectants.

- > Note the manufacturer's specifications for the use of the disinfectants.

Mechanical cleaning internal and external and lubrication



- W&H recommends mechanical cleaning and lubrication with W&H Assistina 3x3.
- > Follow the instructions in the Assistina Instructions for use.

Mechanical cleaning and disinfection internal and external



- The contra-angle handpiece can be cleaned and disinfected in a thermo washer disinfectant.
- > Use the W&H adaptor kit for the thermo washer disinfectant to prepare the external coolant tubes and spray clips.
 - > Note the manufacturer's specifications on equipment, cleaning agents and detergents.



- > Make sure, that the contra-angle handpiece is completely dry internally and externally after thermo washer disinfection. Remove any liquid residues with compressed air.
- > Lubricate the dry contra-angle handpiece immediately after thermo washer disinfection.

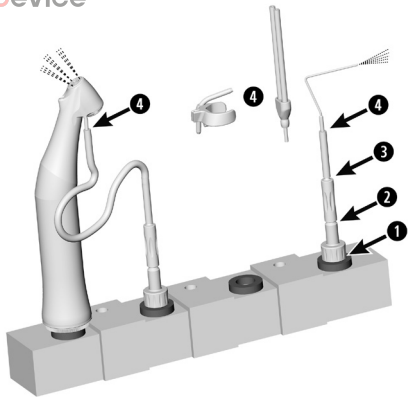

Mechanical cleaning and disinfection of the external coolant tubes



Use the W&H adaptor kit REF 07233500 for the thermo washer disinfector.

- 1 Screw the W&H adaptor into the adaptor on the injector rail.
- 2 Screw the W&H intermediate adaptor onto the W&H adaptor.
- 3 Put the W&H silicone hose over the W&H intermediate adaptor.
- 4 Insert the external coolant tube, the coolant tube for internal bur cooling, the Y-manifold or the spray clip into the W&H silicone hose.

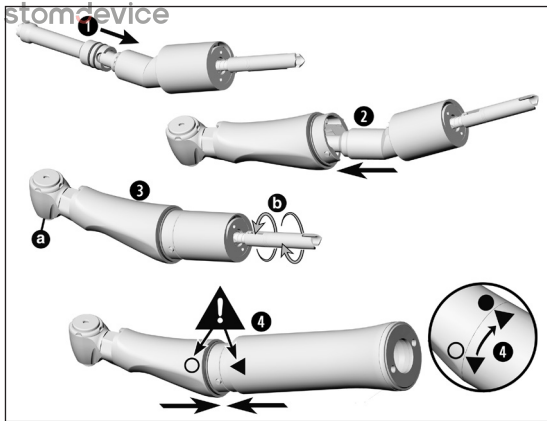

Reassemble contra-angle handpiece

- 1 Insert the middle gear into the knee.
- 2 Insert the knee into the contra-angle head.
- 3 Check free running of the chucking system (a) and shaft (b).
- 4 Insert the sheath onto the contra-angle head. Note the symbols and turn until locked.



Daily oil service

- 1 With W&H Service Oil F1, MD-400
 - > Follow the instructions on the oil spray can and on the packaging.

or

- 2 With W&H Assistina
 - > See Instructions for use of Assistina.

Recommended lubrication cycles

- > Essential after every internal cleaning
- > Before each sterilization

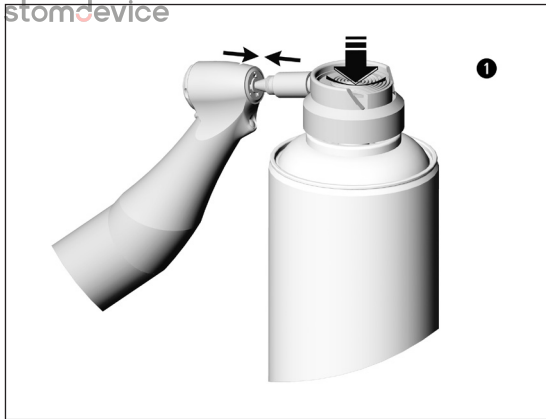

WS-91 L G, WS-91, WS-92 L G, WS-92 Weekly oil service of the chucking system

- 1 With W&H Service Oil F1, MD-400
 - > Fit the spray cap REF 02036100 onto the oil spray can.
 - > Hold the contra-angle handpiece firmly.
 - > Press the tip of the spray nozzle firmly into the chucking system.
 - > Spray for approx. 1 second.

or

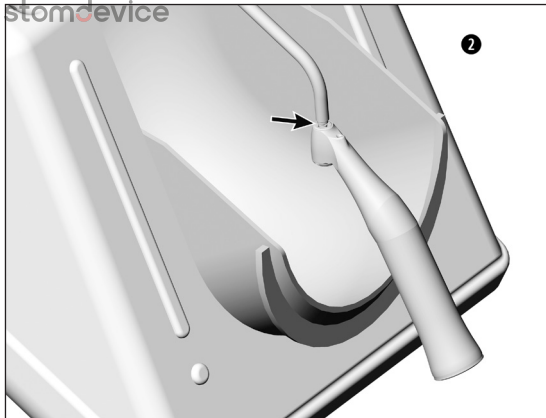

- 2 Only with W&H Assistina 301**
- > Fit the adaptor REF 02693000 onto the maintenance attachment. Direct exit nozzle downwards.
 - > Press the contra-angle handpiece with the chucking system onto the adaptor from below.
 - > Start the Assistina.
 - > Press the chucking system onto the adaptor for approx. 10 seconds.
 - > Remove the contra-angle handpiece from the adaptor.
 - > Close the cover of the Assistina and allow it to run for the remainder of the maintenance cycle [approx. 25 seconds].

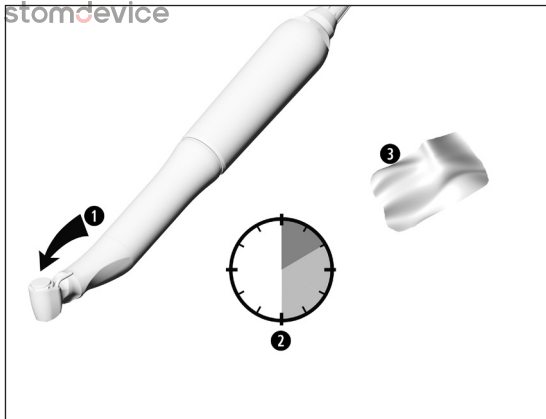

Test run following oil service

- 1 Place the contra-angle handpiece with the contra-angle head downwards.
- 2 Start the contra-angle handpiece for 30 seconds to remove excessive oil. Start at the minimum speed and increase to the maximum speed within 5 to 10 seconds.



Repeat the complete hygiene and maintenance process at any sign of dirt re-emerging.

- 3 Wipe the contra-angle handpiece with gauze or soft cloth.

Sterilization and storage



- > Pull off the spray clip from the contra-angle handpiece before sterilizing.
- > Sterilize the spray clip and the contra-angle handpiece.



W&H recommends sterilization according to EN 13060, class B.
For USA and Canada: Hospital grade sterilization with pre and post vacuum cycle.

- > Note the instructions of the unit manufacturer.
- > Clean, disinfect and lubricate the contra-angle handpiece before sterilizing.
- > Wrap the contra-angle handpiece and the accessory in sterile goods packing according to EN 868-5.
For USA and Canada: Place the contra-angle handpiece and the accessory in a standard handpiece sterilization pouch.
- > Make sure, that you only remove dry sterile goods.
- > Store sterile goods dust-free and dry.



Y-manifold

W&H recommends that the Y-manifold is replaced after 50 sterilization cycles.



Contra-angle handpiece

The standard ISO 7785-2 / ISO 14457 stipulates a durability of at least 250 sterilization cycles. In the case of the contra-angle handpiece from W&H, we recommend you to have a regular service carried out after 1,000 sterilization cycles or one year.

Approved sterilization procedures



Follow your country-specific directives, standards and guidelines.

- > Steam sterilization class B (pre and post vacuum) with sterilizers in accordance with EN 13060. Sterilization holding time a minimum of 3 minutes at 134 °C (273 °F). Required pressure -0.85 bar (-12.3 psi) up to 2.16 bar (31.3 psi).

or

- > Steam sterilization class S with sterilizers in accordance with EN 13060. The sterilizer manufacturer must give its express approval for the sterilization of contra-angle handpieces. Sterilization holding time a minimum of 3 minutes at 134 °C (273 °F).

For USA and Canada

- > Steam vacuum sterilization (hospital grade sterilization), 4 minutes at 134 ±2 °C (273 ±4 °F) or
- > Gravity displacement sterilization, 6 minutes at 134 ±2 °C (273 ±4 °F)
- > All other sterilization methods are not approved and must not be used.

6. W&H Accessories and spare parts



Use only original W&H accessories and spare parts or accessories approved by W&H.
Suppliers: W&H partners

301	Assistina	06016400	Y-manifold (3 pcs)
19922000	Assistina 3x2 (MB-200)	02610500	Coolant tube for internal bur cooling
19923000	Assistina 3x3 (MB-300)	06946300	Spray clip for the left (3 pcs) for Kirschner/Meyer internal bur cooling system
02693000	Assistina adaptor for chucking system	06948300	Spray clip for the right (3 pcs) for Kirschner/Meyer internal bur cooling system
10940021	Service Oil F1, MD-400 (6 pcs)	06948400	Spray clip for the left (3 pcs) without internal bur cooling system
02038200	Spray cap with nozzle	06949500	Spray clip for the right (3 pcs) without internal bur cooling system
02036100	Spray cap with nozzle for chucking system		
07233500	Adaptor kit for the thermo washer disinfector		
02015101	Nozzle cleaner		

7. Technical data

Contra-angle handpiece		WS-56 L G / WS-56	WS-75 L G / WS-75
Transmission ratio		1:1	20:1
Colour coding		blue	green
Motor connection according to standard		ISO 3964	ISO 3964
Rotary instruments	ISO 1797-1 (Ø mm)	2.35	2.35*
Maximum permitted bur length	(mm)	34**	45**
Minimum chucking length		engaging	engaging
Maximum drive speed	(min ⁻¹)	40,000 / 50,000	40,000 / 50,000
Coolant volume	ISO 7785-2 (ml/min)	> 50	> 50
Maximum torque at rotary instrument	(Ncm)	–	70*
Using rotary instrument with hexagon	(Ncm)		105*

min⁻¹ (Revolutions per minute)

* When having a torque higher than 30 Ncm on the rotary instrument you have to use hardened shafts (>50 HRC, >520 HV) [risk of deformation].

** When using longer rotary instruments the user must ensure by correct selection of the operating conditions, that there is no danger to the user, patient or third parties.

7. Technical data

Contra-angle handpiece	WS-91 L G / WS-92 L G	WS-91 / WS-92
Transmission ratio	1:2.7	1:2.7
Colour coding	orange	orange
Motor connection according to standard	ISO 3964	ISO 3964
Rotary instruments ISO 1797-1 (Ø mm)	1.6	1.6
Maximum permitted bur length (mm)	25*	25*
Minimum chucking length	until back stop	until back stop
Maximum drive speed (min ⁻¹)	40.000	50.000
Coolant volume ISO 7785-2 (ml/min)	> 50	> 50

min⁻¹ (Revolutions per minute)

- * When using longer rotary instruments the user must ensure by correct selection of the operating conditions, that there is no danger to the user, patient or third parties.

Temperature information

Temperature of the contra-angle handpiece at the operator side:	maximum 55 °C (131 °F)
Temperature of the contra-angle handpiece at the patient side:	maximum 50 °C (122 °F)
Temperature of the working part (rotary instrument):	maximum 41 °C (105.8 °F)

Physical characteristics

Temperature for storage and transport:	-40 °C to +70 °C (-40 °F to +158 °F)
Air humidity for storage and transport:	8 % to 80 % (relative), non-condensing
Ambient temperature during operation:	+10 °C to +35 °C (+50 °F to +95 °F)
Air humidity during operation:	15 % to 80 % (relative), non-condensing

8. Recycling and disposal

Recycling

W&H considers that it has a special duty towards the environment. The contra-angle handpiece along with its packaging has been designed to be as environmentally friendly as possible.

Disposal of the contra-angle handpiece



- > Follow your country-specific laws, directives, standards and guidelines for the disposal of used electrical devices.
- > Ensure that the parts are not contaminated on disposal.

Disposal of the packaging material



Follow your country-specific laws, directives, standards and guidelines for the disposal.

All packaging materials have been selected according to environmentally compatible and disposal aspects and can be recycled. Please send old packaging materials to the relevant collection and reprocessing system. This way, you will contribute to the recycling of raw materials and the avoidance of waste.

Explanation of warranty terms

This W&H product has been manufactured with great care by highly qualified specialists. A wide variety of tests and controls guarantee faultless operation. Please note that claims under warranty can only be validated when all the directions in the Instructions for use have been followed.

As manufacturer, W&H is liable for material or manufacturing defects within a warranty period of 12 months from the date of purchase.

We accept no responsibility for damage caused by incorrect handling or by repairs carried out by third parties not authorized to do so by W&H!

Claims under warranty – accompanied by proof of purchase – must be sent to the vendor or to an authorized W&H service partner. The provision of service under warranty extends neither the warranty period nor any other guarantee period.

12 months warranty

stomdevice

<https://stomdevice.ru> - стоматологическое и зуботехническое оборудование с доставкой по России и СНГ

Authorized W&H service partners

Find your nearest W&H service partner at <http://wh.com>

Simply go to the menu option »Service« for full details. Alternatively please contact:

W&H (UK) Limited, Unit 6, Stroud Wood Business Centre, Park Street, St Albans, AL2 2NJ Hertfordshire
t + 44 1727 874990, f + 44 1727 872254, E-Mail: technical.uk@wh.com

W&H IMPEX INC., 6490 Hawthorne Drive, Windsor, Ontario, N8T 1J9, Canada
t + 1 519 9446739, f + 1 519 9746121, E-Mail: service.ca@wh.com

W&H IMPEX INC., 14300 Henn Road, Dearborn, MI 48126, USA
t + 1 519 9446739, f + 1 519 9746121, E-Mail: service.us@wh.com

W&H Austria GmbH, Ignaz-Glaser-Straße 53, 5111 Bürmoos, Austria
t + 43 6274 6236-239, f + 43 6274 6236-890, E-Mail: office.at@wh.com

A-DEC Australia, *Office and showroom*, Unit 8, 5-9 Ricketty Street, 2020 Mascot NSW
t + 61 2 8332 4000, f + 61 2 8332 4099, E-Mail: a-dec@a-dec.com.au

Manufacturer

W&H Dentalwerk Bürmoos GmbH

Ignaz-Glaser-Straße 53, 5111 Bürmoos, Austria

t + 43 6274 6236-0,

office@wh.com

f + 43 6274 6236-55

wh.com

Form-Nr. 50755 AEN

Rev. 004 / 25.03.2015

Subject to alterations

